

■ Standard / Universal Ku-band **40W BUC (SSPA)**

MODEL No. **NJT5324/54** series

< **Features** >

- * **Solid State Power Amplifier (SSPA)**
- * **High Efficiency & Low Distortion**
 - P1dB: +46 dBm min. over temperature
 - IM3: -25 dBc max. @ Pout = +43 dBm
 - Power Consumption: 275 W
- * **RF Frequency Band Line-up:**
 - Standard Ku-band: 14.00 to 14.50 GHz
 - Universal Ku-band: 13.75 to 14.50 GHz
- * **AC Power Operating (Option)**
- * **Analog & Digital (RS-485) M&C**
- * **Compact Size & Light Weight**
 - Dimension: 262.2 x 137.7 x 114.3 mm
 - Weight: 4.3 kg



< **Line-Up** >

Model No.	RF Frequency	Local Frequency	IF Frequency	Output Power @ P1dB	Power Supply
NJT5324N	14.00 to 14.50 GHz (Standard Ku-band)	13.05 GHz	950 to 1,450 MHz	40W Linear (+46 dBm min.)	Standard: +36 to +60 V DC Power (Option: 90 to 240 V AC Power with Additional AC/DC Box)
NJT5354N	13.75 to 14.50 GHz (Universal Ku-band)	12.80 GHz	950 to 1,700 MHz		

< **Specifications** >

Item	Specifications
Output Interface	Waveguide, WR75 with Groove
Input Interface	[BUC] IF / Ref.: N-type, female connector (50 ohm) DC Power / M&C: 32 pin MS
	[AC/DC Box] AC Power: 4 pin Amphenol connector M&C(input): 19 pin MS connector
	DC Power / M&C(output): 32 pin MS connector
Output Power @ 1dB G.C.P.	+46 dBm min. over temperature
Linear Gain	70 dB nom.
IM3	-25 dBc max. @ total power = +46 dBm - 3 dB
ACPR	-30 dBc typ. at 1.0 symbol rate offset @ Pout = +44 dBm with QPSK / OQPSK
Requirement for External Reference	[Frequency] 10 MHz (sine-wave)
	[Input Power] -5 to +5 dBm @ Input port
	[Phase Noise] -125 dBc/Hz max. @ 100 Hz, -135 dBc/Hz max. @ 1 kHz, -140 dBc/Hz max. @ 10 kHz
L.O. Phase Noise	-60 dBc/Hz max. @ 100 Hz, -70 dBc/Hz max. @ 1 kHz
	-80 dBc/Hz max. @ 10 kHz, -90 dBc/Hz max. @ 100 kHz
	Compliant with IESS-308
Receive Band Noise Density	-156 dBm/Hz max. @10.95 to 12.75 GHz
V.S.W.R.	[Input] 2 : 1 max. [Output] 1.3 : 1 max.
Power Requirement / Consumption	+36 to +60 VDC / 240 W typ. @ Pout = +43 dBm, 275 W typ. @ Pout = +46 dBm
	AC Power Operating Option (Additional AC/DC Box): 90 to 240 VAC / 320 VA typ. @ Pout = +46 dBm
Monitor and Control	[Analog] Function: Summary Alarm, Tx Control Enable/Disable
	[Digital] Interface: RS-485 (Option: RS-232C / Ethernet)
	Function: RF Power Monitor, Alarm(Summary, Local Unlock, Over Temp.) TX ON/OFF, Step Attenuator
Temperature Range (ambient)	Operating: -40 to +60 C Storage: -40 to +75 C
IP Code (IEC 60529)	IP55 (Dustproof / Waterproof)
Cooling	Forced Air by Fan
Dimension & Housing	BUC: 262.2 mm (L) x 137.7 mm (W) x 114.3 mm (H) [10.32" (L) x 5.42" (W) x 4.50" (H)]
	AC/DC Box: 231.9 mm (L) x 137.7 mm (W) x 88.9 mm (H) [9.13" (L) x 5.42" (W) x 3.50" (H)]
Weight	BUC: 4.3 kg [9.4 lbs] AC/DC Box: 3.2 kg [7.0 lbs]

■ Standard / Universal Ku-band **40W BUC (SSPA)**

MODEL No. **NJT5324/54** series

< Interface Overview >

DC Power

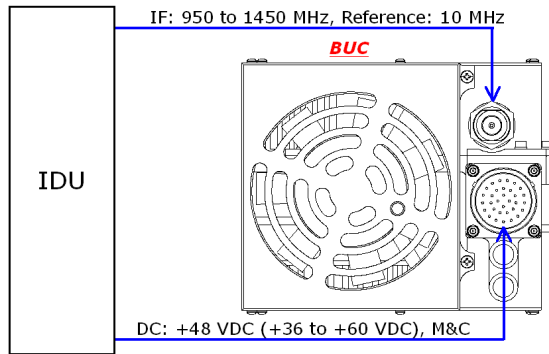

AC Power (Option)

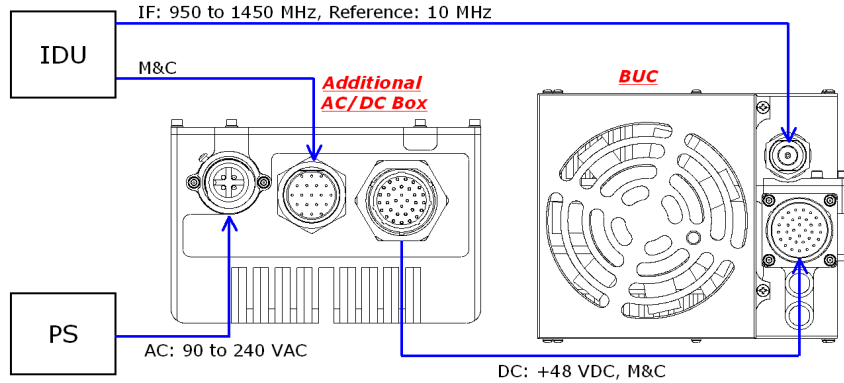

< Outline Drawing >

- BUC -

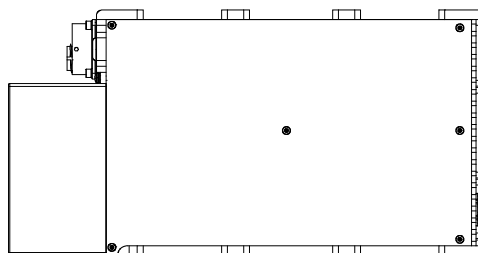
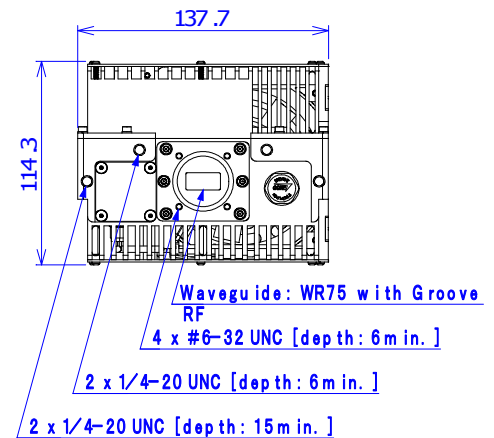
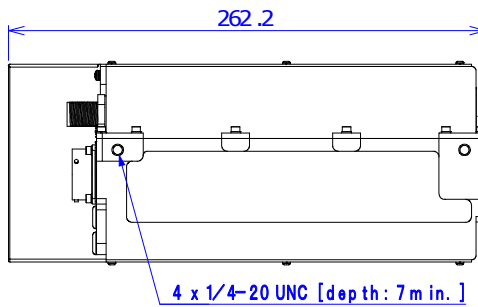
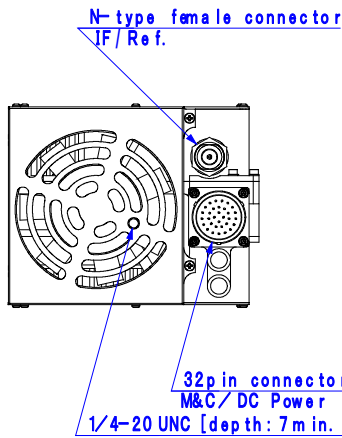
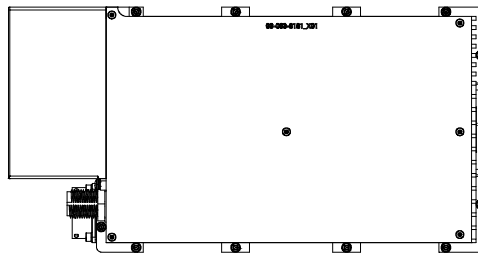

Unit : mm

*Note: The contents of this sheet are subject to change without notice.